

List of Fittings:

TAKE NOTE of all screws!

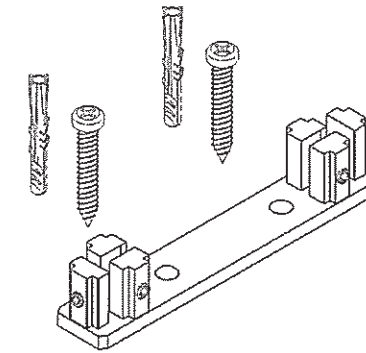

(A) Zinc Bracket (Inclusive of 2 Pan Head Tapping Screws & 2 Wall Plugs)

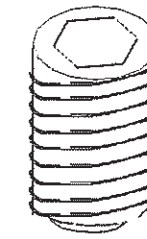

(B) Set Screw, M5 x 8mm

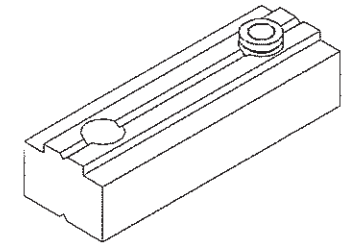

(C) T-Nut & 1 Set Screw (B)

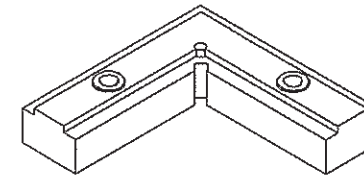

(D) L-Nut & 2 Set Screws (B)

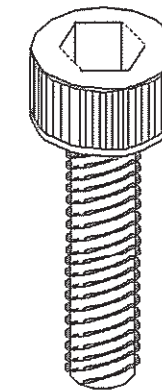

(E) Socket Head Cap Screw, M5 x 20mm

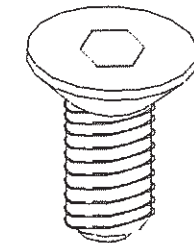

(F) Flat Head Screw, M4 x 12mm; M5 x 12mm

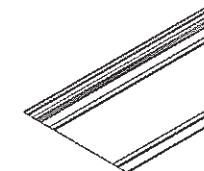

(G) Wall Elbow

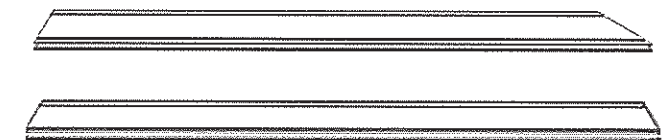

(H) Main Post

List of Tools:

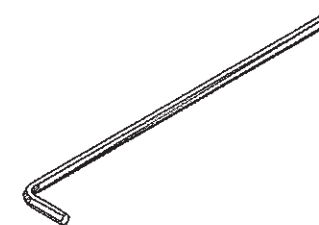

1. Allen Keys (2.5mm; 3.0mm; 4.0mm)

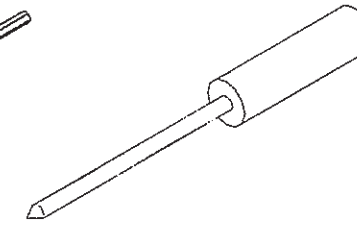

2. Phillips Screw Driver

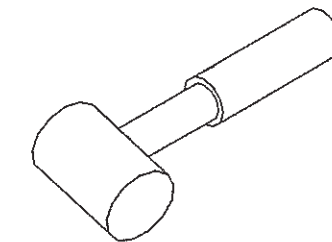

3. Rubber Hammer

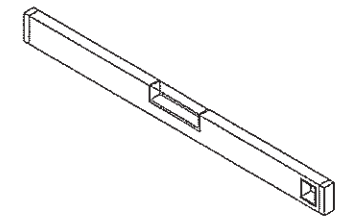

4. Spirit Level